

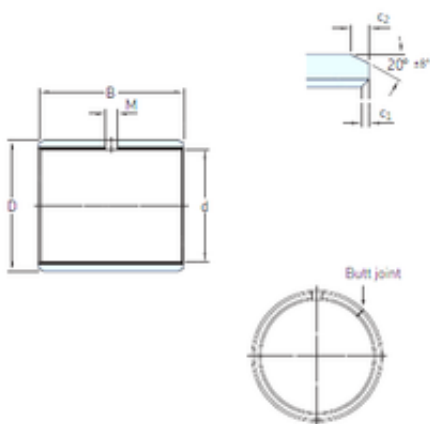

BEARING ITALIA S.P.A

25 mm x 28 mm x 20 mm skf PCM 252820 E Plain bearings, Bushings



Bearing No. PCM 252820 E

Size	25x28x20 mm
Bore Diameter	25 mm
Outer Diameter	28 mm
Width	20 mm
d	25 mm
D	28 mm
B	20 mm
c1 min	0,1 mm
c2 min	0,2 mm
M	– mm
Weight	0,018 Kg
Basic dynamic load rating (C)	38 kN
c ₁ min.	0.1 mm
c ₁ max.	0.7 mm
c ₂ min.	0.2 mm
c ₂ max.	1 mm
± 8	20 °
Tolerance shaft	f7
Tolerance housing	H7
Basic dynamic load rating - radial direction C	38 kN
Basic static load rating - radial direction C ₀	120 kN
Specific dynamic load factor K	80 N/mm ²
Specific static load factor K ₀	250 N/mm ²

PCM 252820 E Bearing 2D drawings and 3D CAD models



BEARING ITALIA S.P.A

Factor depending on material and bearing type K_M	480
Permissible sliding velocity v min.	0 m/s
Permissible sliding velocity v max.	2 m/s
Coefficient of friction μ min.	0.03
Coefficient of friction μ max.	0.25
Mass bushing	0.018 kg